

Mara Chandelier

700TDMRA_ 1.4



These fixtures are intended to be installed utilizing NEC compliant junction boxes.

This product is suitable for damp locations.

This product may be dimmed with a low-voltage electronic dimmer.

The fixture can be mounted to a ceiling with a 35° slope maximum.

This instruction shows a typical installation.

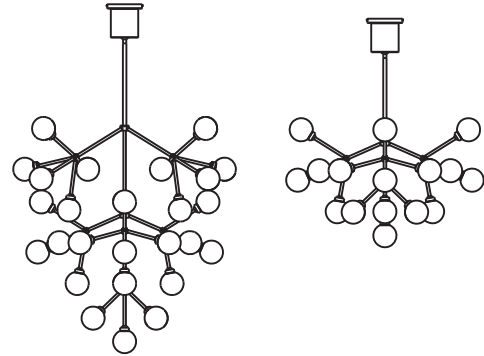

CAUTION - RISK OF FIRE
 This product must be installed in accordance with the applicable installation code by a person familiar with the construction and operation of the product and the hazards involved.
Use minimum 90°C supply conductors.

SAVE THESE INSTRUCTIONS!

Two Person Installation Recommended

Install the Mounting Plate

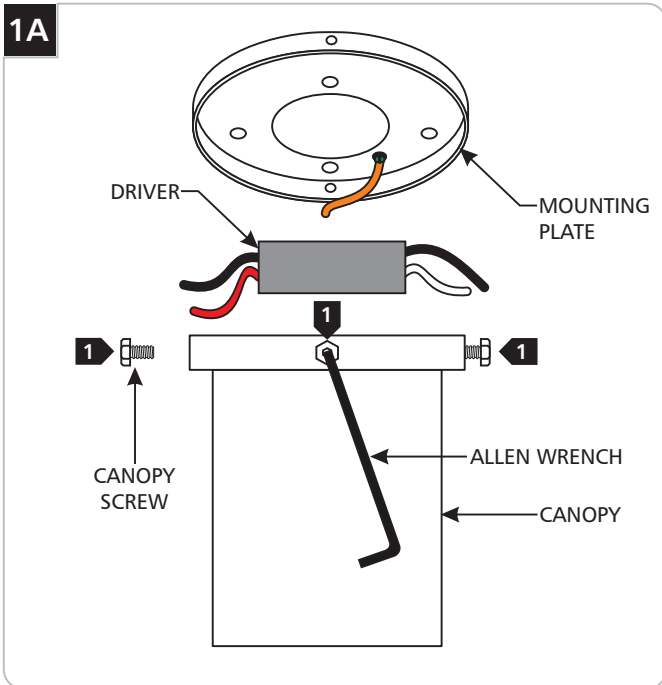

- 1** Remove all the canopy screws using the provided Allen Wrench.
- 2** Remove the mounting plate and driver from the canopy.

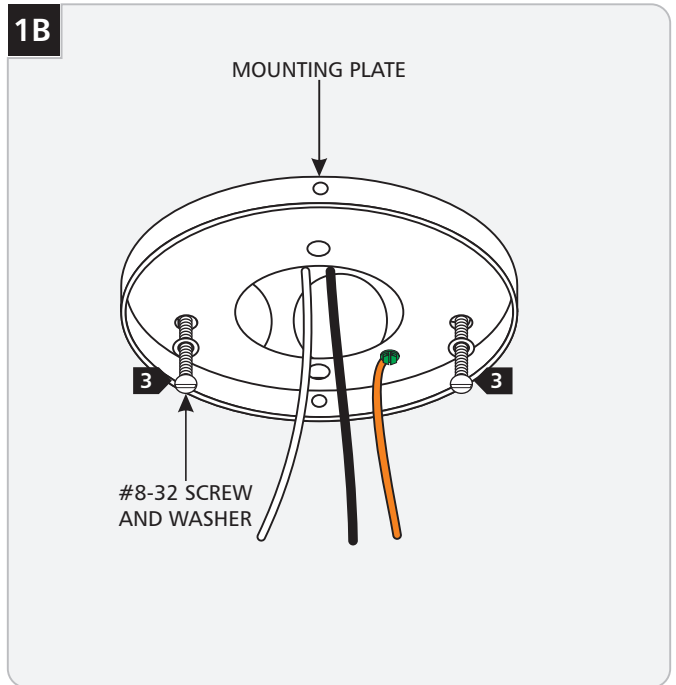

- 3** Secure the mounting plate to the electrical box with the two washers and #8-32 screws provided.

Assemble the Fixture

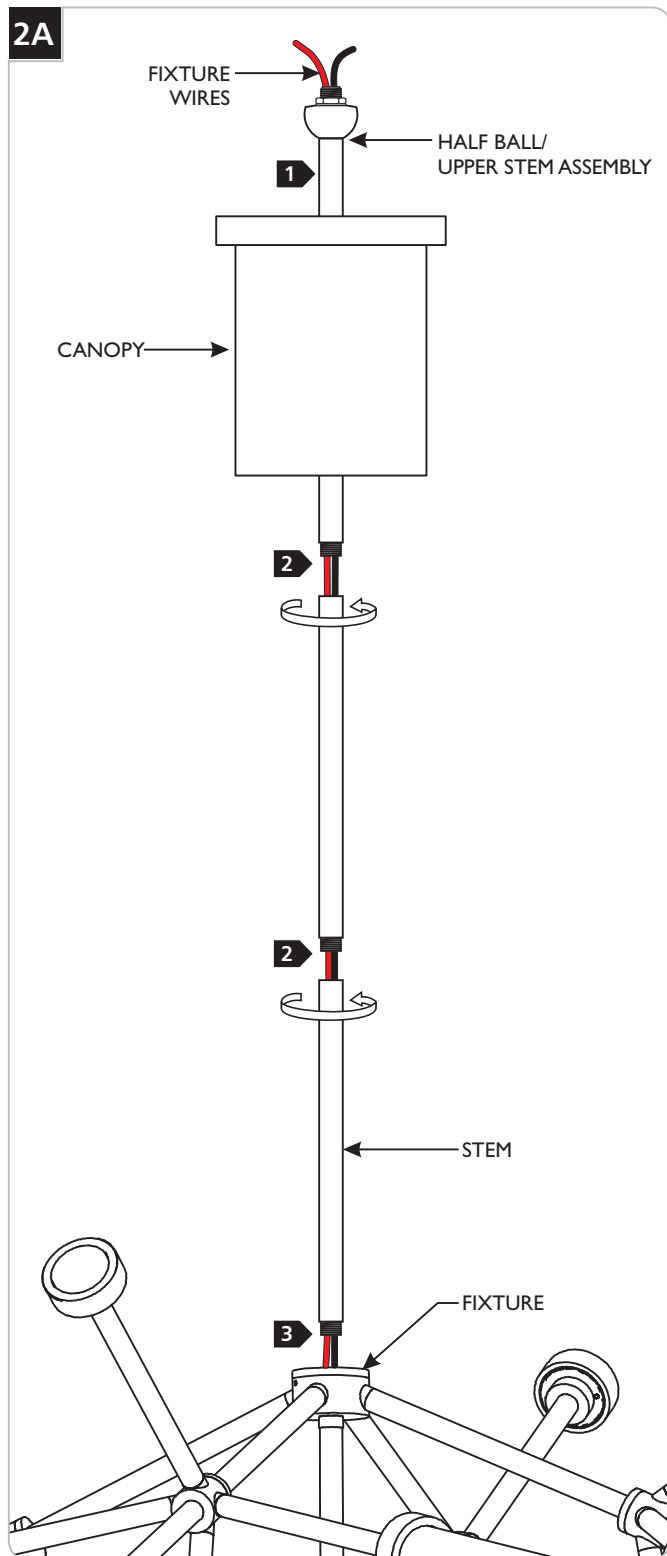

- 1 Feed the half ball/upper stem assembly through the top of the canopy.
- 2 Determine the desired height of the fixture using the provided stems and assemble them by screwing them together.
- 3 Feed the fixture wires through the stem and half ball assemblies, then screw the stem assembly to the fixture.

Install the Fixture

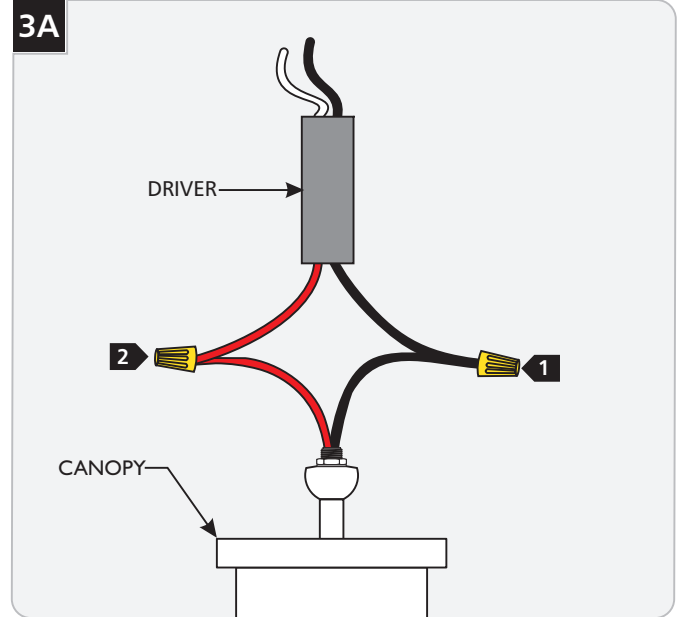

- 1 Connect the black driver wire to the black fixture wire with a wire nut.
- 2 Connect the red driver wire to the red fixture wire with a wire nut.
- 3 Neatly place the driver and wires inside the canopy.

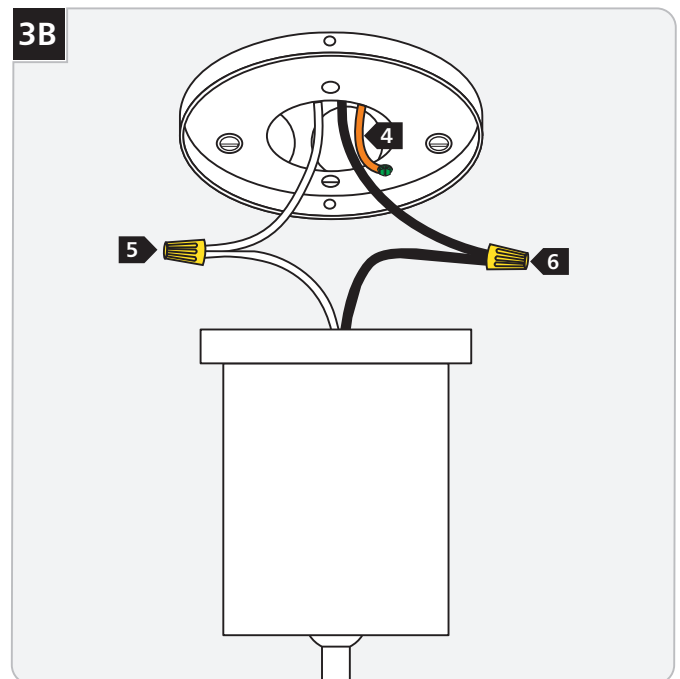

- 4 Connect the fixture to a suitable ground in accordance with local electrical codes.
- 5 Connect the white driver wire to the neutral power line wire with a wire nut.
- 6 Connect the black driver wire to the hot power line wire with a wire nut.

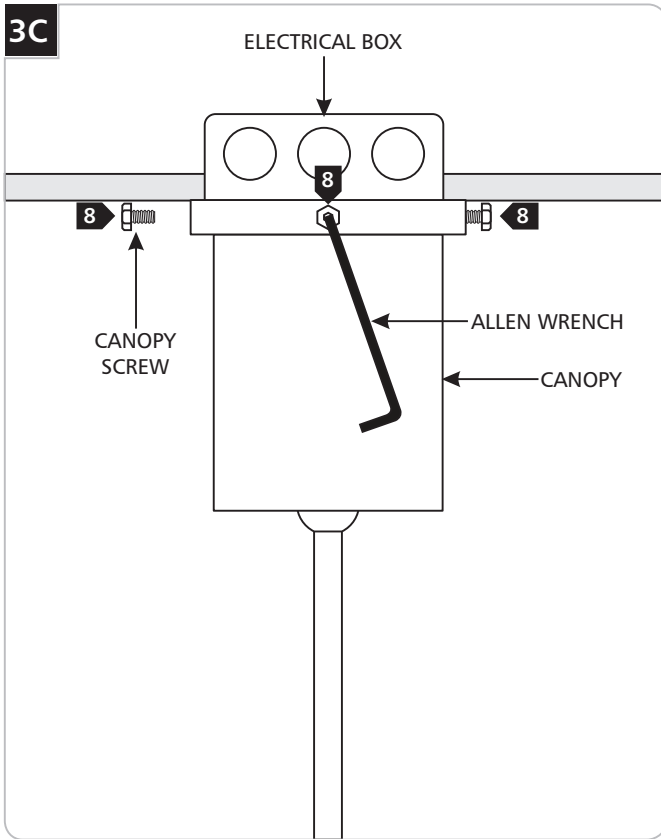

- 7** Neatly place all wires and wire nut connections inside the canopy.
- 8** Align the canopy holes with the mounting plate holes. Secure the canopy in place by tightening the canopy screws using the provided Allen Wrench.
NOTE: The fixture can be mounted to a ceiling with a 42 degree slope maximum.

Install the Glass

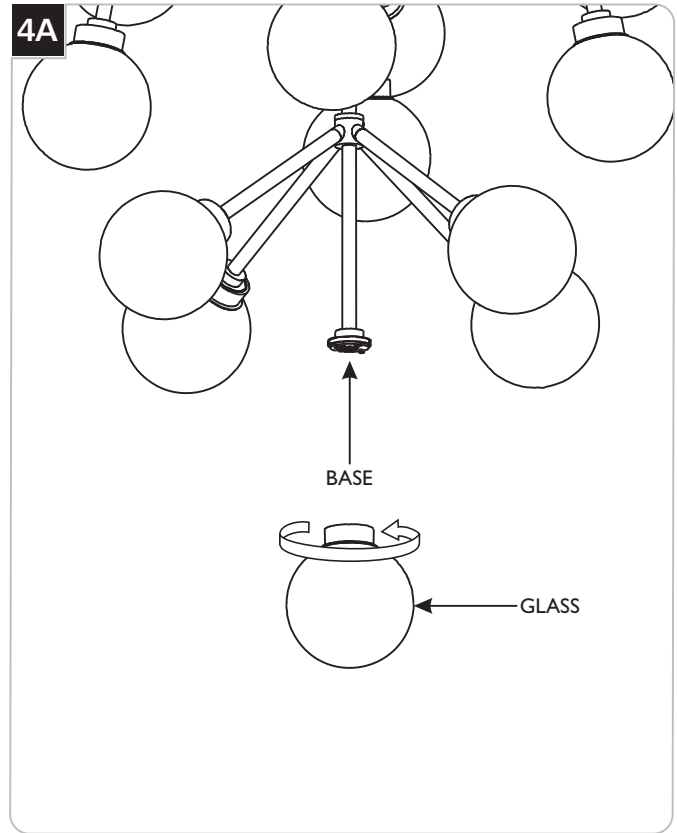

- 1** Install the glass by screwing it into the base. **Do not over-tighten.**



7400 Linder Ave., Skokie, IL 60077

T 847.410.4400 | F 847.410.4500

www.techlighting.com