

# Sage 37 Bath

700BCSAGW37\_

1.0

## VISUAL COMFORT & Co.

MODERN COLLECTION

### BATH COLLECTION

#### GENERAL PRODUCT INFORMATION:



This fixture is intended to be installed utilizing NEC compliant junction boxes.

This product is suitable for damp locations.

This product can be dimmed with a low-voltage electronic dimmer.



**CAUTION - RISK OF FIRE**  
 This product must be installed in accordance with the applicable installation code by a person familiar with the construction and operation of the product and the hazards involved.  
 Use minimum 90°C supply conductors.

### Prepare the Fixture

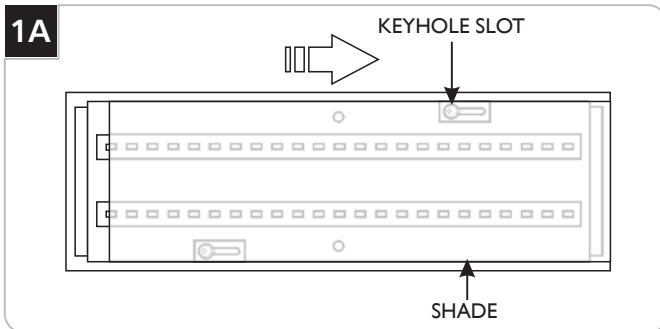

**1** Remove the shade by sliding it all the way over to release it from the keyhole slot, then carefully pull it straight out.

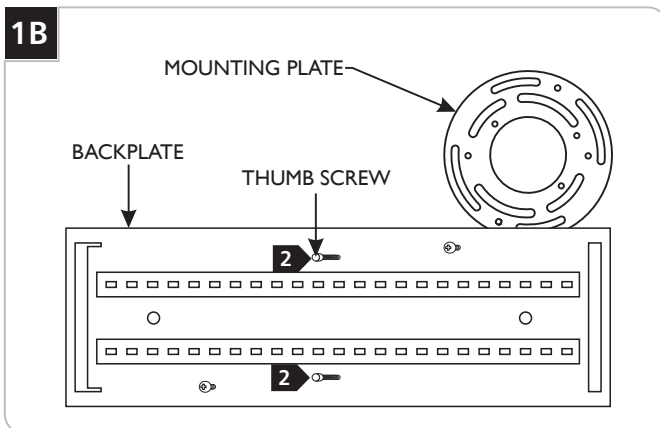

**2** Unscrew the two thumb screws to separate the mounting plate from the backplate.

### Back Plate Installation (Horizontal)

**NOTE:** If mounting vertically, skip to section 4.

**NOTE:** If plaster ring holes are horizontal or mounting onto a octagon electric box, skip to section 3.

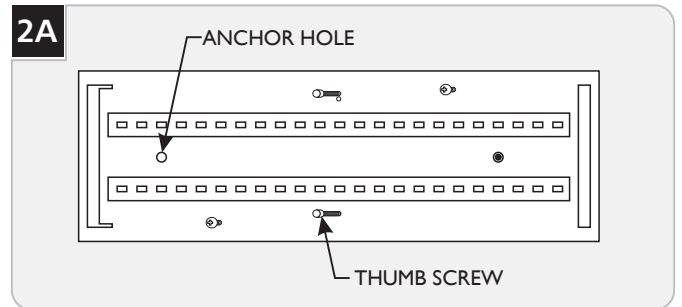

**1** Temporarily mount the fixture onto the mounting plate using the thumb screws, mark the anchor hole locations, and remove the back plate.

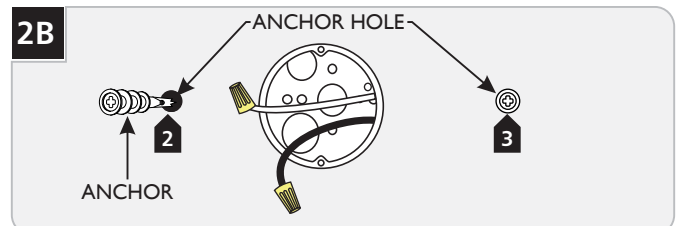

**2** Drill appropriate sized holes at the marked locations and install the anchor into the wall up to the threads.

**3** Screw the anchors in the rest of the way with a Phillips-head screwdriver.

**4** Repeat steps 2-3 for the other anchor.

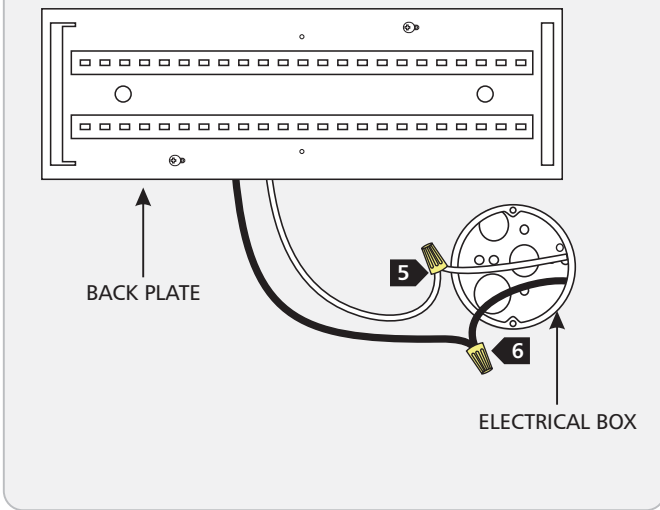
**2C**

- 5** Connect the white fixture wire to the neutral power line wire with a wire nut.
- 6** Connect the black fixture wire to the hot power line wire with a wire nut.
- 7** Connect the fixture to a suitable ground in accordance with local electrical codes.

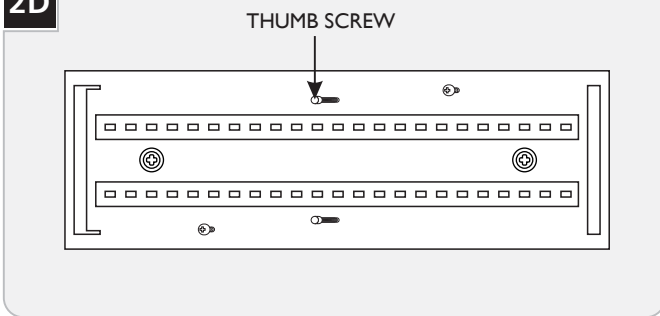
**2D**

- 8** Properly place all wires and wire nut connections into the electrical box.
- 9** Install the mounting plate to the electrical box by completely screwing in the thumb screws.

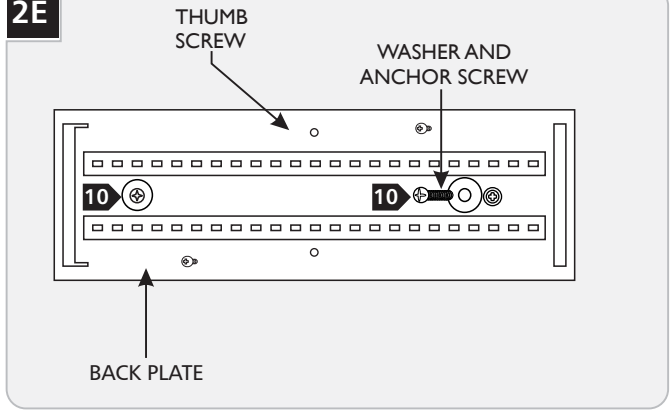
**2E**

- 10** Install washers onto the anchor screws, then fully secure the back plate by screwing the anchor screws into the anchors.

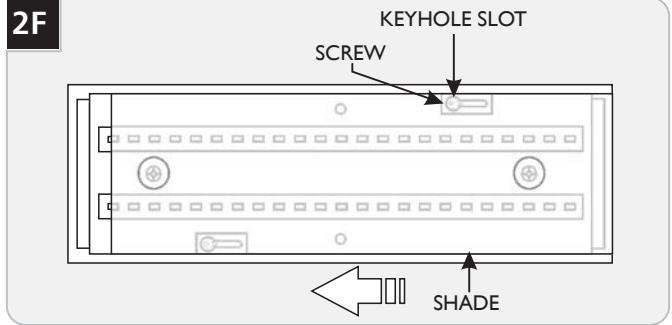
**2F**

- 11** Align the large openings in the keyhole slots on the shade to the screws on the back plate and install the shade onto the backplate.
- 12** Lock the shade in place by sliding it over.

# Back Plate Installation (Horizontal)

(horizontal plaster ring or octagonal electrical box)

**3A**

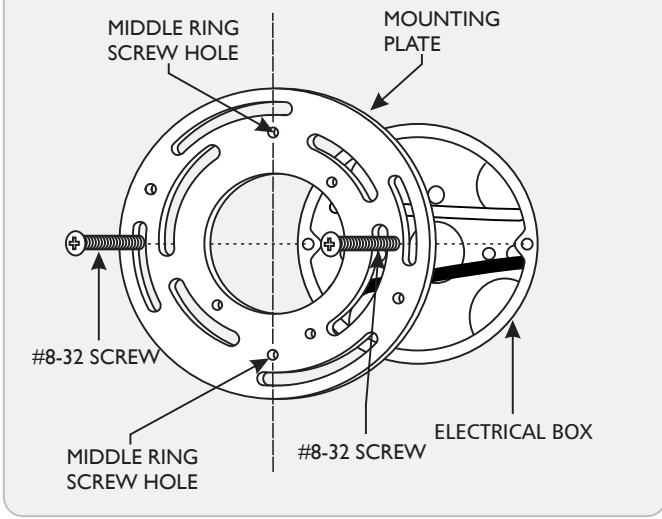

- 1 Align the two screw holes in the middle ring of the mounting plate vertically and secure it to the electrical box with the two #8-32 screws provided.

**3B**

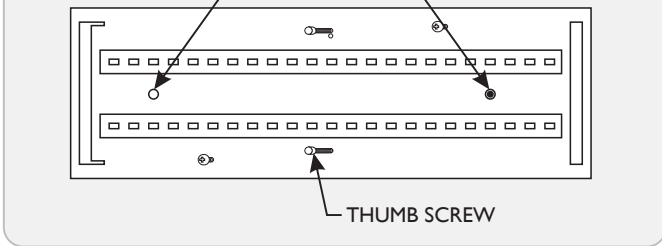

- 2 Temporarily mount the fixture onto the back plate using the thumb screws, mark the anchor hole locations, and remove the fixture.

**3C**

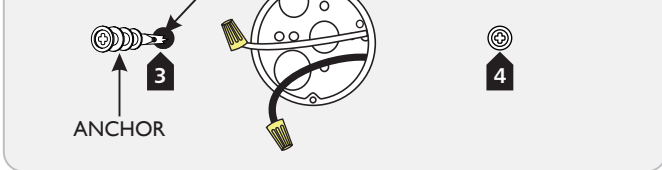

- 3 Drill appropriate sized holes at the marked locations and install the anchor into the wall up to the threads.
- 4 Screw the anchors in the rest of the way with a Phillips-head screwdriver.
- 5 Repeat steps 2-4 for the other anchor.

**3D**

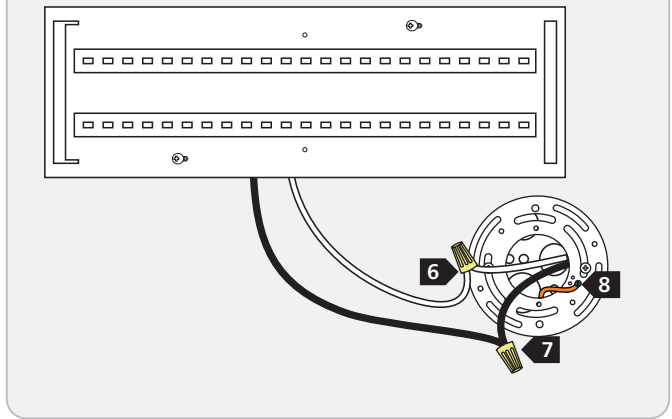

- 6 Connect the white fixture wire to the neutral power line wire with a wire nut.
- 7 Connect the black fixture wire to the hot power line wire with a wire nut.
- 8 Connect the fixture to a suitable ground in accordance local electrical codes.

**3E**

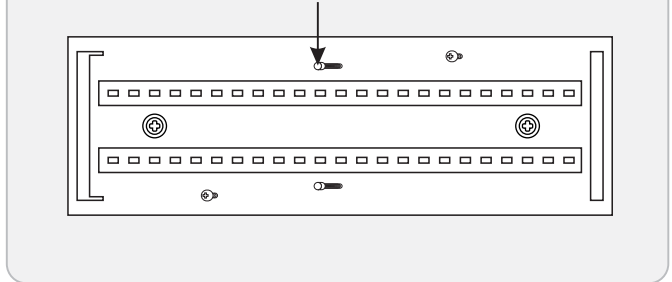

- 9 Properly place all wires and wire nut connections into the electrical box.
- 10 Install the back plate to the mounting plate by completely screwing in the thumb screws.

## Back Plate Installation (Vertical)

**3F**

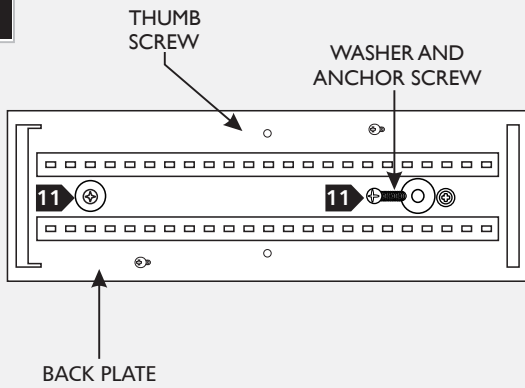

- 11** Install washers onto the anchor screws, then fully secure the back plate by screwing the anchor screws into the anchors.

**3G**

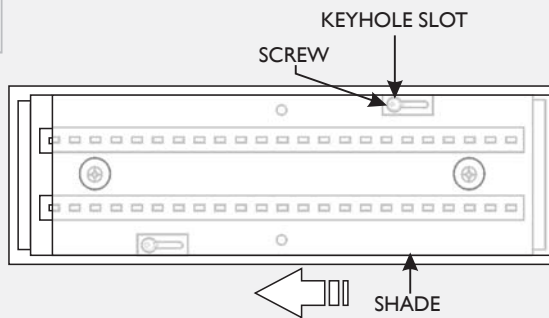

- 12** Align the large openings in the keyhole slots on the shade to the screws on the back plate and install the shade onto the backplate.

- 13** Lock the shade in place by sliding it over.

**NOTE:** If plaster ring holes are vertical or mounting onto a octagon electrical box, skip to section 5.

**4A**

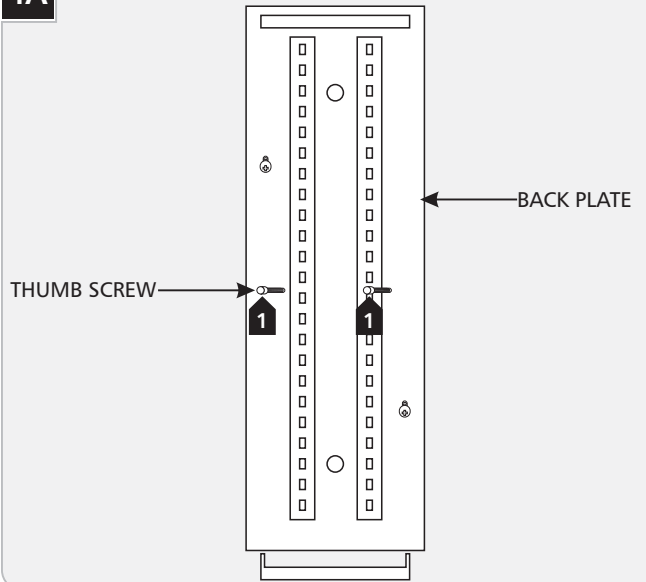

- 1** Temporarily mount the back plate onto the electrical box using the thumb screws, mark the anchor hole locations, and remove the fixture.

**4B**

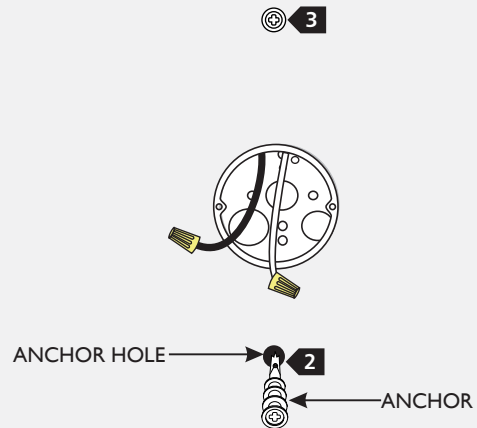

- 2** Drill appropriate sized holes at the marked locations and install the anchor into the wall up to the threads.
- 3** Screw the anchors in the rest of the way with a Phillips-head screwdriver.
- 4** Repeat steps 2-4 for the other anchor.

4C

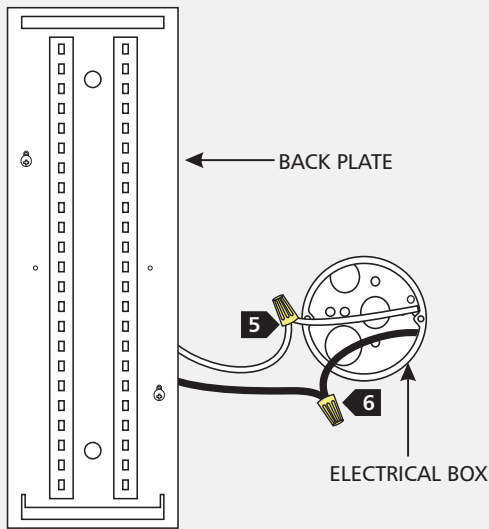

- 5 Connect the white fixture wire to the neutral power line wire with a wire nut.
- 6 Connect the black fixture wire to the hot power line wire with a wire nut.
- 7 Connect the fixture to a suitable ground in accordance with local electrical codes.

4D

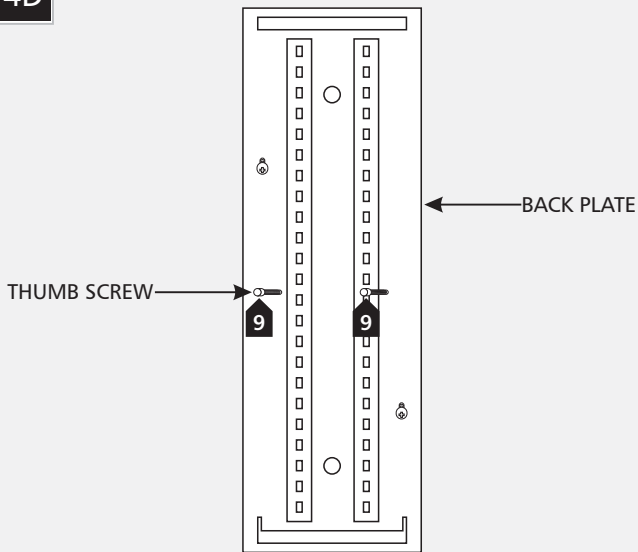

**NOTE:** Ensure that the shade will slide down to lock in place.

- 8 Properly place all wires and wire nut connections into the electrical box.
- 9 Secure the mounting plate to the electrical box by completely screwing in the thumb screws.

4E

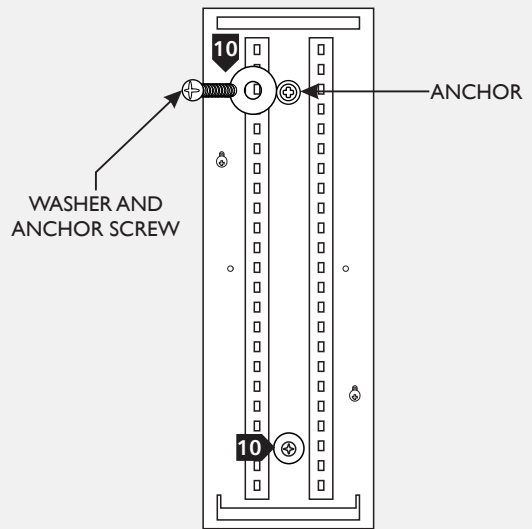

- 10 Install washers onto the anchor screws, then fully secure the mounting plate by screwing the anchor screws into the anchors.

4F

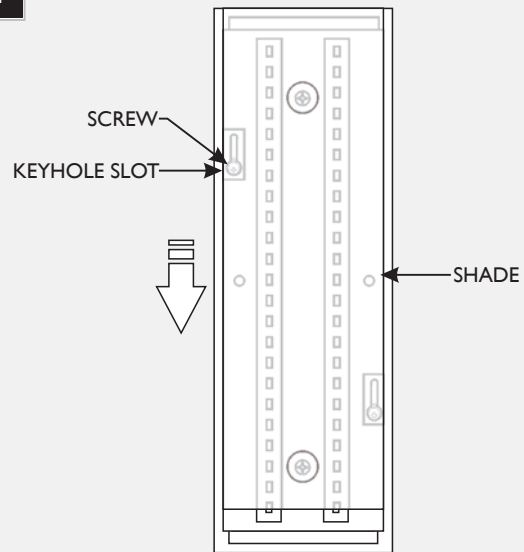

- 11 Align the large openings in the keyhole slots on the shade to the screws on the back plate and install the shade onto the backplate.
- 12 Lock the shade in place by sliding it over.

# Back Plate Installation (Vertical)

(vertical plaster ring or octagonal electrical box)

5A

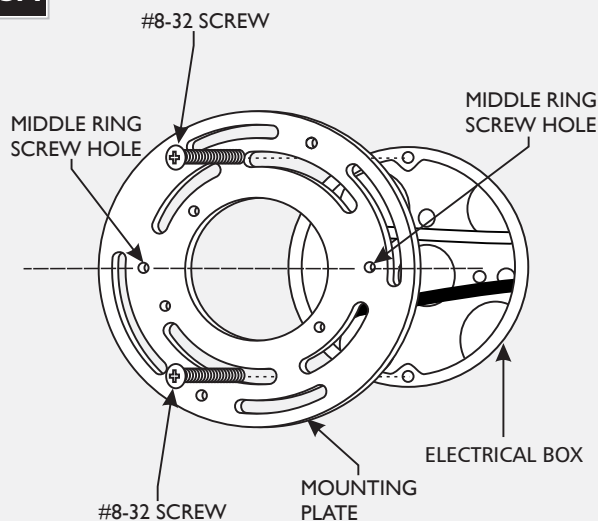

- 1 Align the two screw holes in the middle ring of the mounting plate horizontally and secure it to the electrical box with the two #8-32 screws provided.

5B

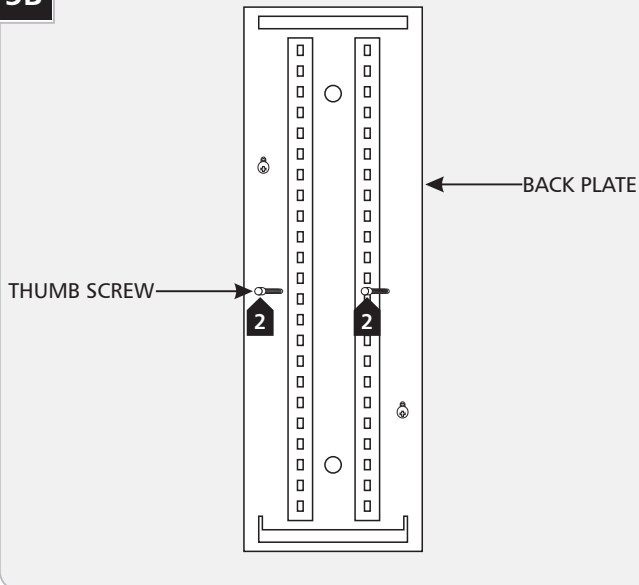

- 2 Temporarily mount the back plate onto the electrical box using the thumb screws, mark the anchor hole locations, and remove the fixture.

5C

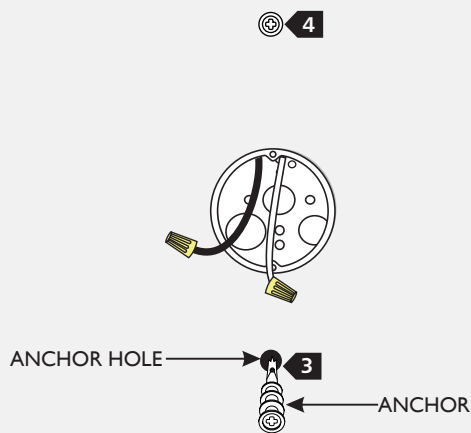

- 3 Drill appropriate sized holes at the marked locations and install the anchor into the wall up to the threads.
- 4 Screw the anchors in the rest of the way with a Phillips-head screwdriver.
- 5 Repeat steps 3-4 for the other anchor.

5D

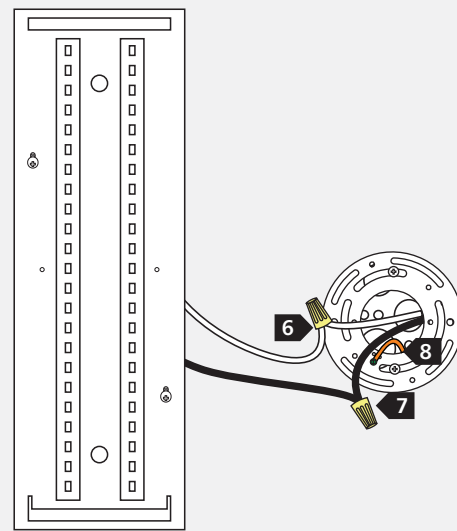

- 6 Connect the white fixture wire to the neutral power line wire with a wire nut.
- 7 Connect the black fixture wire to the hot power line wire with a wire nut.
- 8 Connect the fixture to a suitable ground in accordance with local electrical codes.

5E

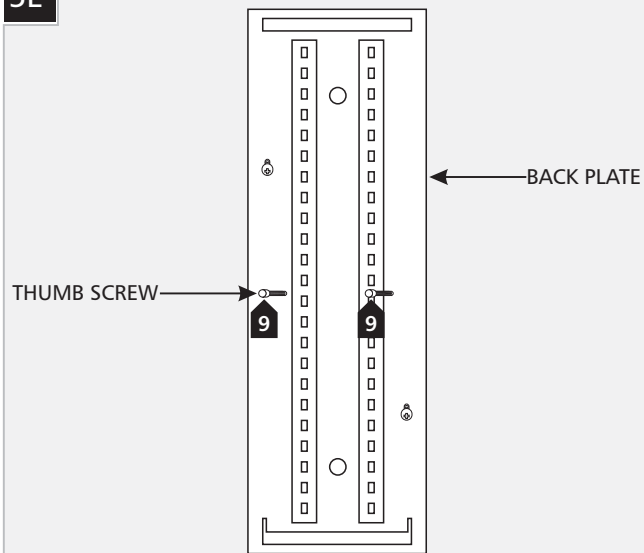

**NOTE:** Ensure that the shade will slide down to lock in place.

- 8 Properly place all wires and wire nut connections into the electrical box.
- 9 Secure the back plate to the mounting plate by completely screwing in the thumb screws.

5F

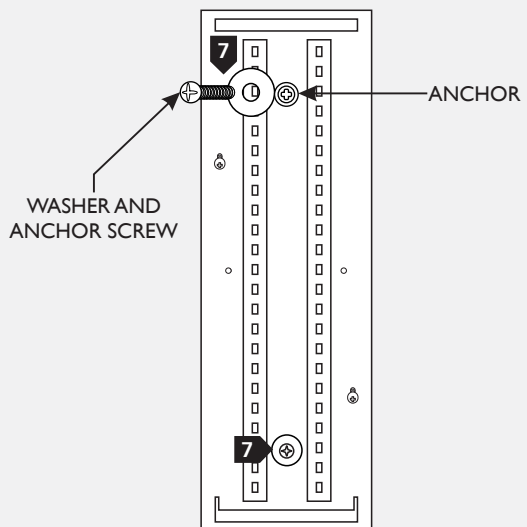

- 10 Install washers onto the anchor screws, then fully secure the mounting plate by screwing the anchor screws into the anchors.

5G

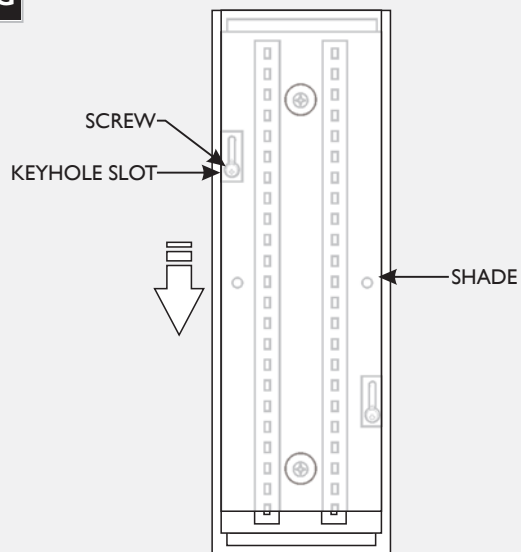

- 11 Align the large openings in the keyhole slots on the shade to the screws on the back plate and install the shade onto the backplate.
- 12 Lock the shade in place by sliding it over.

**SAVE THESE INSTRUCTIONS!**

VISUAL COMFORT & CO.

7400 Linder Ave, Skokie, IL 160077

800.969.3347

**[www.visualcomfort.com](http://www.visualcomfort.com)**

©2023 Visual Comfort & Co.. All rights reserved. The Visual Comfort & Co. logo is a registered trademark of Visual Comfort & Co. Visual Comfort & Co. reserves the right to change specifications for product improvements without notification