

# Soft Turnbuckles

700KSOF TT S

1.7



## GENERAL PRODUCT INFORMATION:



This product is suitable for indoor dry locations only.

This product should be used with Tech Lighting Kable Lite system only.

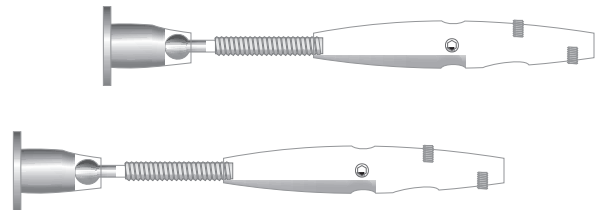

## Install the Soft Turnbuckles

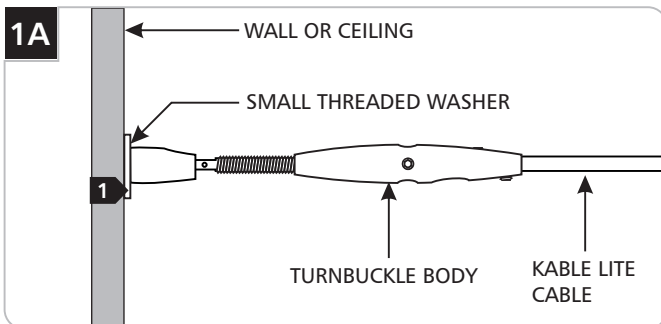

**1** Use the small threaded washer when the Kable Lite cable is attached in-line to the soft turnbuckle.

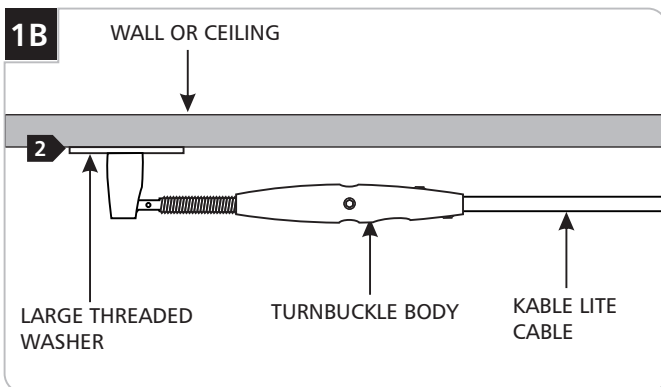

**2** Use the large threaded washer when the Kable Lite cable is attached at an angle to the soft turnbuckle.

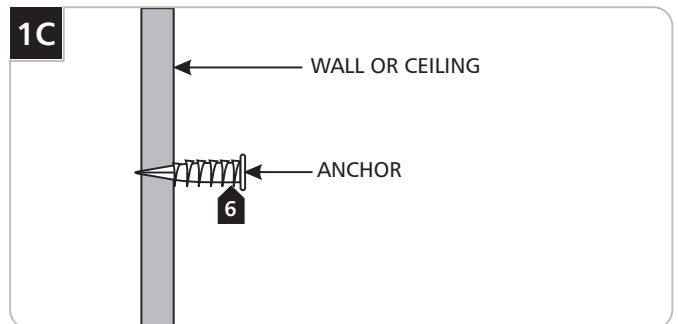

**3** Select the right location for the anchors to be mounted.

**4** Decide the Kable Lite cable separation. 1" is the minimum separation allowed (use the small threaded washer in this case).

**5** Mark the location of the anchors on the wall or ceiling. The distance between the center points of the anchors should be the desired Kable Lite cable separation.

**6** Tap the anchors at the marked point up to the threaded portion with a hammer.

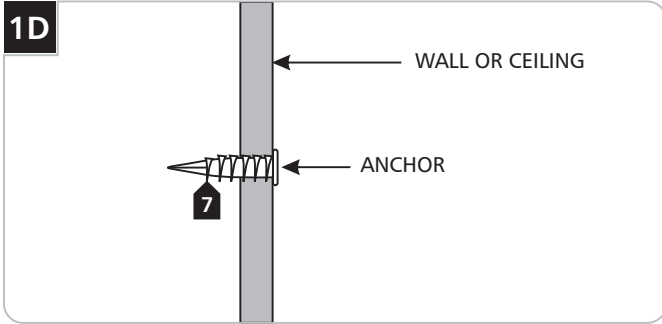

**7** Screw the anchors in the rest of the way with a Phillips screwdriver.

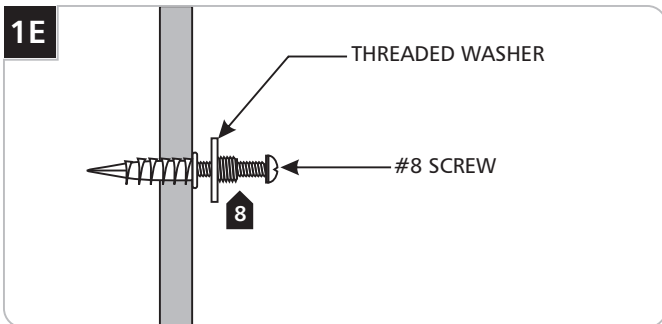

**8** Attach the threaded washer to the anchor with the #8 screw.

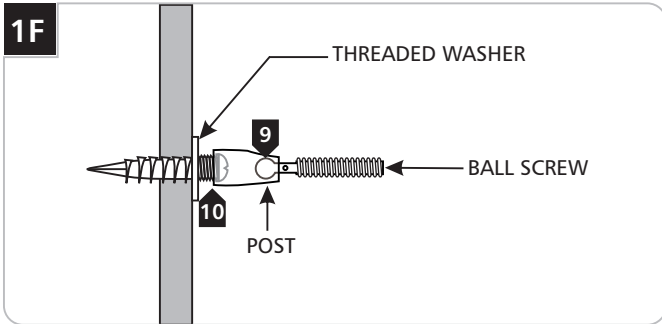

**9** Place the ball screw into the post.  
**10** Screw the post onto the threaded washer.

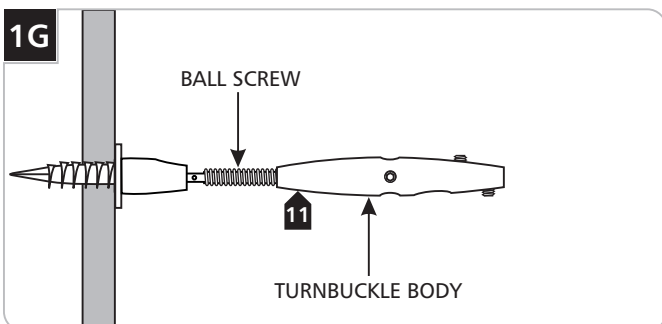

**11** Screw the turnbuckle body to the ball screw.

## Install the Kable Lite Cables

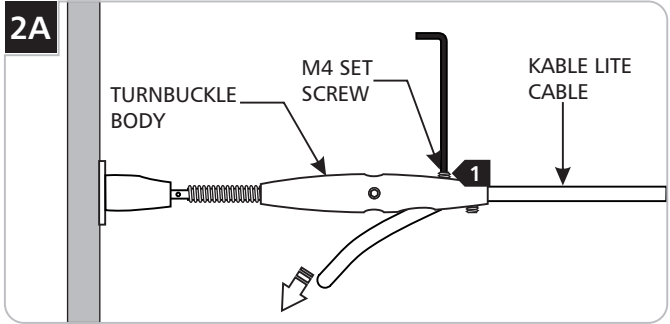

**NOTE:** When power feed wires are going to be connected to the turnbuckle bodies (Fig 3A on page 3) and insulated Kable Lite cables are used in the system, strip the end portion of the Kable Lite cables (that are going to be attached to the turnbuckle bodies) so that the power is conducted through the turnbuckle bodies to the Kable Lite cables. This does not apply for isolated slimline turnbuckles.

- 1** Insert one end of the Kable Lite cables into the turnbuckle body and tighten the two M4 set screws with the 2 MM Allen wrench.
- 2** Insert the other end of the Kable Lite cable into the opposite turnbuckle body. Pull the Kable Lite cable taut between the two turnbuckles and tighten the M4 set screws with the 2 MM Allen wrench.
- 3** Repeat steps 1 and 2 for the other turnbuckle set.

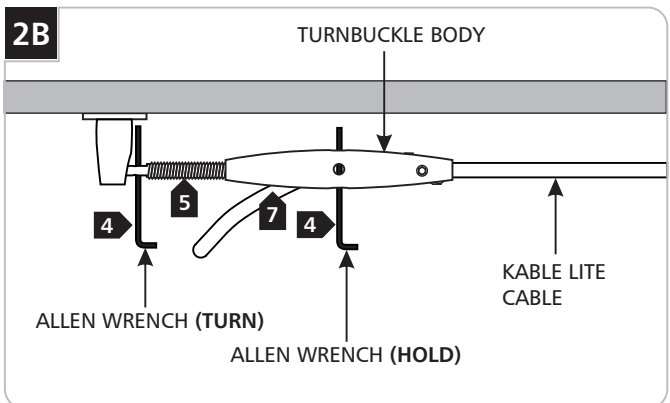

- 4** Finish tightening the Kable Lite cables taut by inserting one Allen wrench into the turnbuckle body hole and another one into the ball screw hole.
- 5** Hold the turnbuckle body Allen wrench while turning the ball screw Allen wrench counterclockwise.
- 6** Repeat steps 4 and 5 for the other turnbuckle set.
- 7** Trim off the excess Kable Lite cables coming out of the turnbuckle bodies.

## Connecting the Power Line Wires Directly to the Soft Turnbuckles

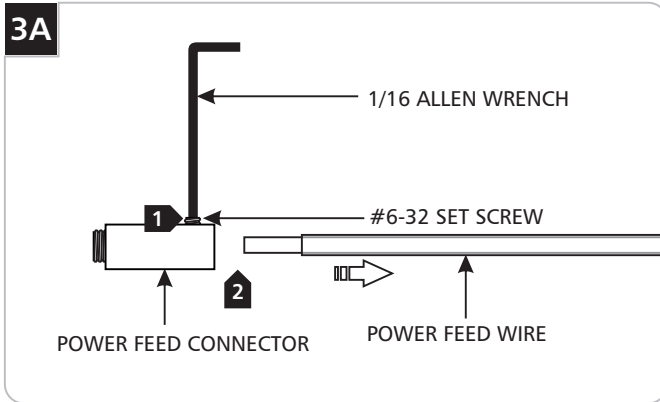

- 1 Loosen the #6-32 set screw on the power feed connectors with the 1/16 Allen wrench.
- 2 Remove the power feed connectors.

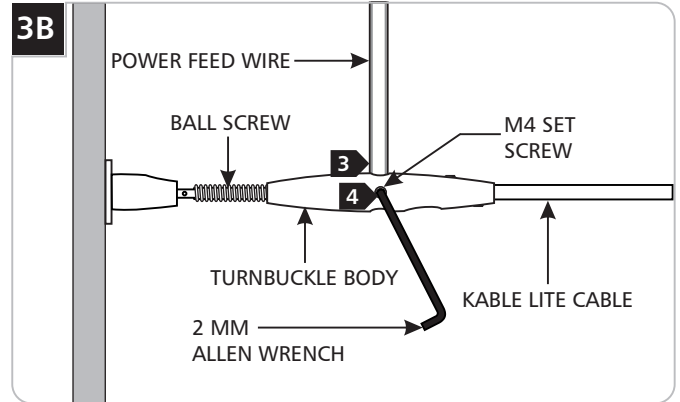

- 3 Feed the striped portion of the power feed wire (one for each turnbuckle) into the turnbuckle hole.
- 4 Tighten the M4 set screw with the 2 MM Allen wrench.

**SAVE THESE INSTRUCTIONS!**



7400 Linder Ave, Skokie, IL 60077  
847.410.4400

[www.techlighting.com](http://www.techlighting.com)

© 2008 Tech Lighting, L.L.C. All rights reserved. The "Tech Lighting" graphic is a registered trademark of Tech Lighting, L.L.C. Tech Lighting reserves the right to change specifications for product improvements without notification.  
A Generation Brands Company